

Straight-through parallel female thread coupler



BSPF female thread

G 1/2

Operating pressure

0 to 10 bar

Flow rate

24 l/min ($\Delta P = 0,3$ bar with shutter), 33,5 l/min ($\Delta P = 0,3$ bar without shutter)

ID Passage

9 mm

Temperature

-15°C to +60°C

Construction

Brass body

Description

Reference	BSPF female thread
ELS 090103	G 1/2
ELS 090104	G 3/4
ELS 090105	G 1

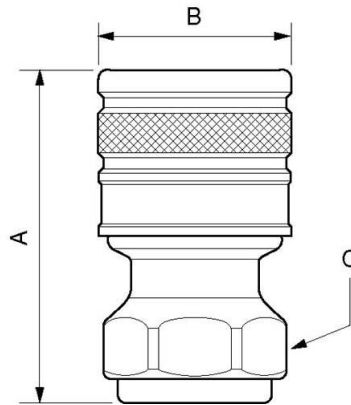

Dimensions

Reference	A mm	B mm	C mm
ELS 090103	61	35	30
ELS 090104	61	35	30
ELS 090105	62.5	35	38