

ALTO 2 - 2-piece-set - Filter-Regulator-Lubricator (gauge included) with wall bracket and diverter block

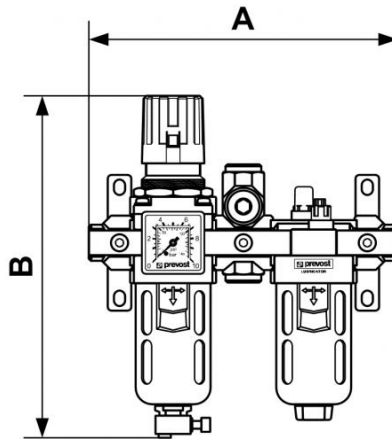

<p><u>BSPF female thread</u> G 3/8</p>	<p><u>Flow rate (l/min at 7 bar ΔP)</u> 1bar) = 1250</p>	<p><u>Max operating pressure (bar)</u> 12</p>	<p><u>Filtration (μm)</u> 25</p>
<p><u>Temperature</u> +5°C to +50 °C</p>	<p><u>Construction</u> Body : Aluminium Polycarbonate bowl with metallic protection</p>	<p><u>Equipped with</u> Manual drain</p>	

Description				
Reference	BSPF female thread	Flow rate (l/min at 7 bar ΔP)	Max operating pressure (bar)	Filtration (μm)
TB SME2	G 3/8	1bar) = 1250	12	25



Dimensions

Reference	A mm	B mm
TB SME2	204	220